

SECTION 3

PRICES AND ILLUSTRATIONS OF

ANTI-SQUEAK	FASTENERS-glass channel, moulding, trim and weatherseal	RINGS-hog
BALLS-bearing	FITTINGS-grease	RUN-window
BOLTS-carriage, hex. head and spring center	GASKETS-annular	SOCKETS-glove fastener
BUMPERS-rubber	INSERTS-spring	STUDS-plain and fastener
BUTTONS-curtain dot, glove fastener and plug	KEYS-feather, woodruff	SHIMS-weatherstrip
CAPS-finishing	LINER	SCREWS-cap, binding head, cross recess head, drive, fillister head, finishing, flat head, hex. head, pan head, round head, washer head and set
CLAMPS-hose	MOULDINGS-reveal and window	TUBING-copper and rubber
CLIPS-cable and clevis	NUTS-acorn, anchor, hex. ma- chine screw, pal slotted, speed, tube and wing	UNIONS-tube
COCKS-drain	NIPPLES-tube	WASHERS-finishing, lock, plain and spring
CONNECTORS-tube	PINS-clevis, dowel, grooved, straight, taper	WEATHERSEAL
CUPS-grease and oil	PLUGS-expansion and pipe	WEATHERSTRIP
CUSHION-glass and top bow	RIVETS-tubular	
ELBOWS-tube		
EYELETS-fastener		

LENGTHS OF BOLTS

Square, Hex., Oval, Button, Cone and Round head bolts and screws are measured under the head. Countersunk head bolts and screws are measured over all.













ABBREVIATIONS

The following abbreviations appear frequently in this list:













Hex.	Hexagon
In.	Inside
I. D.	Inside Diameter
O. D.	Outside Diameter
No. 10-32	Size 10, 32 threads to the inch
No. 5X3/4"	Size 5, 3/4 inch long
5/8"-11	5/8" in diameter, 11 threads per inch
7/16"-14X2-1/2"	7/16" in diameter, 14 threads per inch and 2-1/2" long.

PARTS PRICE LIST

1025X













PART NUMBER		NAME	LIST PRICE	DEALER NET	PREF. NET	PART NUMBER		NAME	LIST PRICE	DEALER NET	PREF. NET	
OLD	NEW					OLD	NEW					
												
		5X DOWEL PIN, STEEL Diameter-Length						Type "A"				
5X68		1/8"X39/64"	5/.12	20/.24	20/.30	75X34						
								Type "B"				
								75X TUBULAR FLAT HEAD RIVET, BRASS Diameter-Length				
									100/.45	100/.32	100/.37	
												
		7X FEATHER KEY Thick-Width-Length						403XA-403XB SPRING INSERT Length				
7X31		3/8"X3/8"X1-7/8"	.17	.10	.13	403XB20		20"	ea. .51	.31	.38	
								In Pkgs. of 50				
												
		40X LOCK WASHER, STEEL Diameter of Bolt						778X CURTAIN DOT PLUG BUTTON, BRASS Hole Diameter				
40X125		5/16"	100/.30	100/.15	100/.19	778X32W		15/16"	.12	5/.35	5/.44	
40X376		No. 8	100/.30	200/.20	200/.25	778X33W		3/8"	.08	5/.25	5/.31	
40X377		No. 10	100/.38	100/.19	100/.24							
												
		41X PLAIN WASHER, STEEL Inside Diameter						959X WINDSHIELD WIPER RUBBER TUBE I.D. - O.D.				
41X147		3/8" Fibre	.03	5/.10	5/.13	959X		7/32"X13/32"	Ft. .12	.06	.08	
41X243		13/32"	.03	5/.10	5/.13			I.D. - LENGTH				
41X444		13/32"	2/.03	48/.36	48/.45	959X12		7/32"	12"	.12	.06	.08
						959X19		7/32"	19"	.20	.10	.13
												
		42X CLEVIS PIN Diameter-Length to Pin Hole						997X HOG RING				
42X60		3/16"X31/64"	.03	10/.15	10/.19	997X			100/.10	100/.05	100/.06	
												
		63X SLOTTED HEX. NUT Diameter-Thread						1025X GLOVE FASTENER SOCKET BUTTON Length				
63X8		1/2"-20	.05	10/.30	10/.38	1025X1W		5/16"	.05	8/.24	8/.30	
63X19		7/8"-14	.25	.15	.19	1025X2W		3/8"	.05	8/.24	8/.30	
63X33		1"-14	.30	2/.30	2/.38							

PARTS PRICE LIST











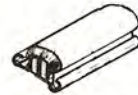

PART NUMBER		NAME	LIST PRICE	DEALER NET	PREF. NET	PART NUMBER		NAME	LIST PRICE	DEALER NET	PREF. NET
OLD	NEW					OLD	NEW				
											
		1048X SPECIAL BINDING HEAD PILOT DRIVE SCREW Diameter-Length				1403X2		1403X BUMPER, RUBBER 1"A-1/2"B	.10	.06	.08
1048X5		No. 6X3/4"	.02	30/.30	30/.38						
											
		1093X FINISHING MOULDING SCREW Diameter-Thread-Length				1421X1		1421X TRIMMING FASTENER For 9/32" Hole	.03	10/.20	10/.25
1093X6		No. 6-32X1/2"	.03	5/.10	5/.13						
1093X42		No. 10-24X11/16"	.03	10/.20	10/.25						
1093X43		No. 10-24X1/2"	.03	10/.20	10/.25						
											
		1160X ANTI-SQUEAK, FELT Thick-Width-Length				1458X1		1458X TRIMMING FASTENER For 1/4" Hole	.03	20/.30	20/.38
1160XBH10		3/8"X2"X10"	.15	.09	.11	1458X2		For 7/32" Hole	.02	10/.10	10/.13
						1458X10		For 3/16" Hole	.03	5/.10	5/.13
		1258X TUBING, Rubber I. D. - Length									
1258XL8		1/4"-8"	.10	.06	.08						
											
		1259X FINISHING BINDING CAP, Right				1463X1		TYPE "A" TYPE "B" 1463X SPRING WASHER Inside Diameter			
1259X1W			.07	.04	.05	1463X14		11/32"-A	.03	10/.20	10/.25
								25/64"-A	.03	.02	.03
		1260X FINISHING BINDING CAP, Left									
1260X1W			.07	.04	.05						
											
		1294X WEATHERSTRIP, RUBBER Thick-Width-Length				1479XW		1479X GLASS CUSHION Thick-Width			
1294XAE94		1/2"-1/2"-94"	1.00	.60	.75	1479XAB		3/32"X1-1/8"	Ft. .08	.05	.06
								3/32"X1-3/8"	Ft. .10	.06	.07
		1542X SPEED NUT									
						1542X1		For No. 4 Machine Screw	.03	10/.20	10/.25
						1542X5		For No. 6 Machine Screw	.03	10/.20	10/.25
						1542X11		For No. 8-15 Metal Screw	.03	20/.40	20/.50
						1542X33		For No. 6 Metal Screw	.02	40/.40	40/.50

PARTS PRICE LIST

1618X











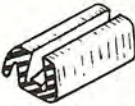
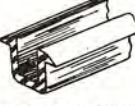

PART NUMBER		NAME	LIST PRICE	DEALER NET	PREF. NET	PART NUMBER		NAME	LIST PRICE	DEALER NET	PREF. NET	
OLD	NEW					OLD	NEW					
												
		1546X GLOVE FASTENER SOCKET						1580X FASTENER STUD Diameter-Thread-Length				
1546X1W			.05	8/.24	8/.30			No. 10-32X1/4"	.07	6/.24	6/.30	
												
		1570X CAP SCREW - Acme Thread Diameter-Thread-Length						1581X FASTENER STUD Diameter-Length				
1570X3		5/16"-10X3/4"	.03	10/.20	10/.25			No. 8X5/8"	.07	.04	.05	
1570X4		5/16"-10X1"	.03	10/.20	10/.25			No. 7X3/4"	.07	5/.20	5/.25	
												
		1571X SPEED NUT						1587X DOOR WEATHERSTRIP SHIM Diameter				
1571X2		For 1/4"-20 Screw	.03	10/.20	10/.25			5/16"	Ft. .15	.09	.11	
												
		1572X SPEED NUT						1590X REAR WINDOW MOULDING, Rubber Developed Length				
1572X1		For No. 8 Sheet Metal Screw	.03	10/.20	10/.25			73"	2.83	1.70	2.12	
								77-1/2"	2.85	1.71	2.14	
		1574X MOULDING FASTENER						88"	3.09	1.85	2.31	
1574X		For 1/4" Hole	.03	20/.30	20/.38			82-1/2"	2.95	1.77	2.21	
												
		1578X SPEED NUT						1592X QUARTER WINDOW MOULDING, Rubber Developed Length				
		Screw Size						44"	2.31	1.39	1.74	
1578X1		No. 10	.03	10/.20	10/.25			46-3/4"	2.31	1.39	1.74	
1578X5		No. 8	.03	10/.20	10/.25			52-1/8"	2.57	1.54	1.93	
1578X6		No. 10	.03	5/.10	5/.13							
1578X7		No. 10-24	.03	5/.10	5/.13							
1578X10		1/4"	.03	5/.10	5/.13							
1578X18		No. 8	.03	10/.20	10/.25							
1578X23		5/16"-18	.04	5/.12	5/.15							
1578X25		5/16"-10	.05	10/.30	10/.38							
1578X27		5/16"-10	.05	5/.15	5/.19							
												
		1618X WINDOW GLASS WEATHERSEAL Length						1618XB19-1/2	19-1/2"	.36	.22	.27

PARTS PRICE LIST







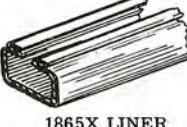







PART NUMBER		NAME	LIST PRICE	DEALER NET	PREF. NET	PART NUMBER		NAME	LIST PRICE	DEALER NET	PREF. NET
OLD	NEW					OLD	NEW				
											
		1622X SPECIAL SPEED NUT						1690X WEATHERSEAL Width-Diameter			
1622X1		For No. 8 Screw	.05	5/.15	5/.19	1690X1A12-1/2		3/4"-1/2"	.17	.10	.13
											
		1624X WEATHERSEAL FASTENER						1691X WINDOW GLASS WEATHERSEAL			
1624X1		For 1/4" Hole	.02	20/.20	20/.25	1691XA18-5/8			.25	.15	.19
											
		1627X FASTENER						1692X DOOR WEATHERSEAL, RUBBER			
1627X1		For 9/32" Hole	.03	20/.30	20/.38	1692X		In Pkgs. of 60 feet	Ft. .12	.07	.09
											
		1628X SPEED NUT						1706X WINDOW GLASS RUN			
1628X1		For No. 10 Screw	.03	10/.20	10/.25	1706XA54-1/4			1.34	.80	1.01
						1706XA82			2.00	1.20	1.50
		1641X SPEED NUT				1706XB46-1/2			1.13	.68	.85
1641X1		For No. 8 Screw	.05	10/.30	10/.38	1706XB84-3/8			2.06	1.23	1.54
											
		1642X MOULDING FASTENER						1718X FASTENER CLINCH STUD			
1642X1			.02	25/.25	25/.31	1718X1W			.05	.03	.04
											
		1680X WINDSHIELD WEATHERSTRIP Length						1719X FASTENER CLINCH BASE EYELET			
1680X1		120"	4.75	2.85	3.56	1719X1W			.05	8/.24	8/.30
1680X2		125"	5.00	3.00	3.75						
								1743X SPEED NUT			
						1743X1		For 5/16" Screw	.05	10/.30	10/.38
						1743X2		For 1/4" Screw	.03	10/.20	10/.25
						1743X8		For No. 14 Screw	.03	10/.20	10/.25
						1743X9		For No. 14 Screw	.04	10/.20	10/.25

PARTS PRICE LIST

1865X









PART NUMBER		NAME	LIST PRICE	DEALER NET	PREF. NET	PART NUMBER		NAME	LIST PRICE	DEALER NET	PREF. NET
OLD	NEW					OLD	NEW				
1743X13		For 5/16" Screw	.05	20/.50	20/.63						
1743X14		For 5/16" Screw	.05	20/.50	20/.63						
											
		1763X WEATHERSTRIP Length									
1763X1		125"	5.00	3.00	3.75						
											
		1770X GLASS CUSHION Length									
1770X56			.65	.39	.49						
											
		1783X SPEED NUT									
1783X1		For 5/16" Screw	.05	10/.30	10/.38						
1783X2		For No. 14 Screw	.05	10/.30	10/.38						
											
		1792X SPEED NUT									
1792X2		For No. 10 Screw	.03	5/.10	5/.13						
											
		1811X SPEED NUT									
1811X3		For No. 14 Screw	.03	10/.20	10/.25						
1811X4		For 1/4"-20 Screw	.03	.02	.03						
											
		1834X FASTENER SOCKET									
1834X1W			.07	4/.16	4/.20						
											
		1835X WINDOW WEATHERSEAL Length									
1835X29-3/4		29-3/4"	.31	.19	.24						
											
		1840X CAP SCREW ACME THREAD Diameter-Length									
1840X2		5/16"X1-3/8"	.05	10/.30	10/.38						
											
		1848X WEATHERSEAL Length									
1848X29-3/4		29-3/4"	.40	.26	.33						
											
		1858X TOP BOW CUSHION Length									
1858X38-1/2		38-1/2"	.51	.34	.42						
											
		1859X WEATHERSTRIP Length									
1859X33-1/4		33-1/4"	.51	.31	.39						
											
		1862X WEATHERSEAL Length									
1862X45-1/2		45-1/2"	.46	.30	.37						
											
		1863X WINDOW GLASS RUN Length									
1863XA16-7/8		16-7/8"	.46	.28	.35						
											
		1865X LINER Length									
1865X34-1/16		34-1/16"	1.39	.91	1.13						

PARTS PRICE LIST

PART NUMBER		NAME	LIST PRICE	DEALER NET	PREF. NET	PART NUMBER		NAME	LIST PRICE	DEALER NET	PREF. NET
OLD	NEW					OLD	NEW				
											
		1879X CABLE CLIP						1903X ROD END CLEVIS CLIP			
1879X1			.03	5/.10	5/.13				.03	.02	2/.05
									.03	5/.10	5/.13
		1882X GLASS CHANNEL FASTENER							.12	4/.28	4/.35
1882X1		For 9/16"X3/16" Hole	.03	.02	.03				.03	.02	2/.05
											
		1883X SPEED NUT						1904X HEX HEAD MACHINE SCREW AND INTERNAL TOOTH LOCK WASHER ASSY. Diameter-Thread-Length			
1883X1		For .125 Diameter Stud	.01	40/.20	40/.25				.05	8/.20	8/.25
1883X2		For .187 Diameter Stud	.01	50/.25	50/.31				.07	4/.14	4/.18
1883X3		For .0937 Diameter Stud	.01	50/.25	50/.31						
1883X5		For .0937 Diameter Stud	.01	20/.10	20/.13						
											
		1885X MOULDING FASTENER						1905X HEX HEAD MACHINE SCREW AND DISH TOOTH LOCK WASHER ASSY. Diameter-Thread-Length			
1885X1		For 7/32" Hole	.03	10/.20	10/.25				.05	8/.20	8/.25
									.07	4/.14	4/.18
		1892X REVEAL MOULDING									
1892X44-3/8			.57	.34	.42						
											
		1893X DOOR WEATHERSTRIP Length						1906X HEX HEAD SELF - TAPPING SCREW AND INTERNAL TOOTH LOCK WASHER ASSY. Diameter-Thread-Length			
1893X36		36"	.62	.37	.46				.05	8/.20	8/.25
									.05	4/.10	4/.13
		1902X ROD END CLEVIS CLIP							.05	8/.20	8/.25
1902X2			.03	.02	2/.05				.06	4/.12	4/.15
1902X3			.03	5/.10	5/.13						
1902X15			.10	4/.24	4/.30						
											
		1917X TRIM FASTENER						1921X CLIP			
1917X1		For 9/32" Hole	.03	20/.30	20/.38				.02	10/.10	10/.13
											
		1921X CLIP									
1921X1		For 5/32" Hole	.02	10/.10	10/.13						

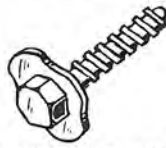
PARTS PRICE LIST

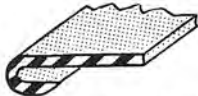
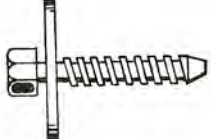
1992X

PART NUMBER		NAME	LIST PRICE	DEALER NET	PREF. NET	PART NUMBER		NAME	LIST PRICE	DEALER NET	PREF. NET
OLD	NEW					OLD	NEW				
											
		1940X MOULDING Length						1959X STUD Diameter-Thread-Length			
1940X13-1/4		13-1/4"	.75	.45	.56	1959X2		No. 10-24X1"	.03	.02	2/.05
											
		1942X WEATHERSTRIP OR CHANNEL Length						1960X HEX. HEAD MACHINE SCREW AND PLAIN WASHER Diameter-Thread-Length			
1942X1		131"	5.00	3.00	3.75	1960X1		5/16"-18X5/8"	.05	10/.25	10/.31
1942X2		146 1/2"	5.25	3.15	3.94	1960X2		1/4"-20X5/8"	.05	10/.25	10/.31
											
		1951X ROUND HEAD RECESS MACHINE SCREW AND EXTERNAL INTERNAL TOOTH LOCK WASHER ASSY. Diameter-Thread-Length						1962X HEX. HEAD ACME THREAD SCREW AND DISH TOOTH LOCK WASHER ASSY. Diameter-Length			
1951X1		No. 12-24X1/2"	.04	10/.20	10/.25	1962X1		5/16"X1"	.10	.05	.06
											
		1954X OVAL HEAD CROSS RECESS MACHINE THREADLOCK SCREW Diameter-Thread-Length						1990X WEATHERSEAL Length			
1954X1W		No. 8-32X3/4" ea. In Pkgs. of 20	.03	.02	2/.05	1990X29		29"	.30	.18	.23
											
		1957X HEX. HEAD ACME THREAD SCREW AND PLAIN WASHER ASSY. Bolt Diameter-Length-Washer O. D.						1992X WEATHERSTRIP Length			
1957X1		5/16"X1 1/4"-2"	.17	10/.85	10/1.06	1992X26-3/4		26-3/4"	.45	.29	.36
1957X2		5/16"X3/4"-7/8"	.08	10/.40	10/.50						
											
		1958X WEATHERSTRIP OR CHANNEL Length									
1958X1		131"	5.00	3.00	3.75						
1958X2		146-1/2"	5.25	3.15	3.94						